

DATALOGIC - SAFETY RELAY CSME

CSME-03VU24-Y14

RELAY CSME-03VU24-Y14 EDM Type

- Cost effective safety relay
- 3 NO safety relay outputs, need EDM control
- 2 inputs for OSSD's



PRODUCT DESCRIPTION

Datalogic safety relay CSME is a low cost safety relay who can be used together with all SG and SE series light curtains that have EDM function (External Device Monitoring). CSME relay does not have internal monitoring so EDM control is compulsory.

By CSME safety relay the OSSD's from safety light curtain can be changed to potential free relay contacts.

With proper EDM connection it maintain the same safety level as safety light curtain who is connected to CSME relay.

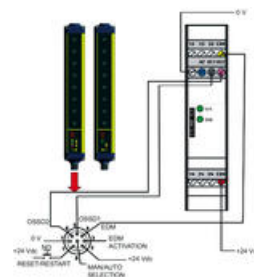
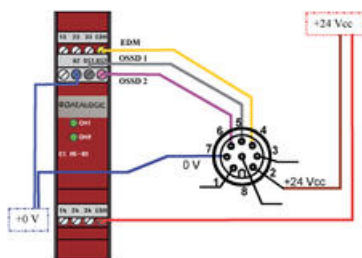

Connection example

Connection to SG4 safety light curtain



TECHNICAL DATA

Supply voltage	24 V DC
Tolerance	+/- 20 %
Rated power consumption	< 2 W max
Start power consumption	< 3 W max
Safe outputs	3 NO force guided relay contact + 1 NC contact for EDM

Max. switching current	6 A
Max. switching voltage	230/240 VAC, 300 VDC
Disconnection time	40 ms
Status indication	2 x LED
Ingress protection class:	IP40 (housing), IP20 (terminal block)
Operating temperature	-25 °C to +55 °C
Material	Housing: Polyamid PA 6.6 class V0 (UL94)
Weight	200 g
Dimensions (L x H x D)	111,5 x 99,0 x 22,5 mm
Mechanical endurance	> 10 millions operations
Electrical endurance	> 100.000 operations
Standard conformity	EN 60204-1, EN 954, EN 999, EN 1037, EN ISO 12100-1, EN ISO 12100-2, EN 418, EN 60529, EN 61000-6-2, EN 61000-6-3, EN 62326-1, EN 60664-1, EN 60947-1, UL 508, CSA C22.2 n°14- 95
Directory conformity	2006/95/EC, 2006/42/EC, 2004/108/EC
Approval	  UL file E131787

DIMENSIONS

Dimensions (L x H x D)	111.5 x 99.0 x 22.5 mm
------------------------	------------------------

CONNECTION

Terminals

Terminal	Connection
EDM: (red)	24 VDC (power supply)
EDM: (yellow)	to EDM input (light curtain)
A2:	0 VDC (power supply)
OS1:	OSSD1 (from light curtain)
OS2:	OSSD2 (from light curtain)
13-14	NO safety relay output
23-24	NO safety relay output
33-34	NO safety relay output

Connection examples

Connection to SG4 safety light curtain

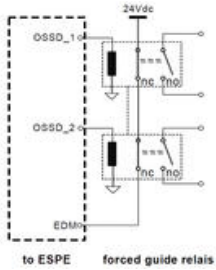
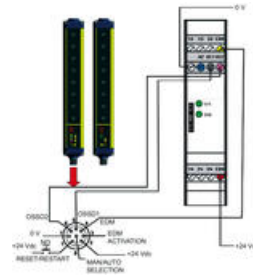
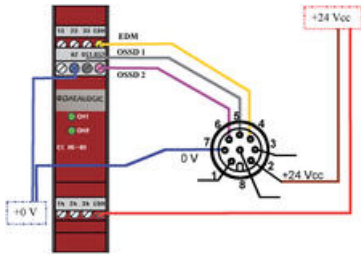

ORDER NUMBERS

Order no.	Description	Output
CSME-03VU24-Y14	Safety relay Datalogic CSME, 3 NO, 24 V DC (EDM control is compulsory)	3 NO relay

SPECIFICATIONS

Contact Current Max	6 A
Contact Voltage Max	230/240 V AC, 300 VDC
Dimension (mm)	91 x 99 x 22.5 mm
IP Class Connection	IP20
IP Class Housing	IP40
Material Protection	Polyamide 6.6
Mounting	DIN rail
Power Consumption	<2 W max.
Response time	40 ms
Supply voltage	24 V DC
Tolerance	± 15 %
Weight	200 g

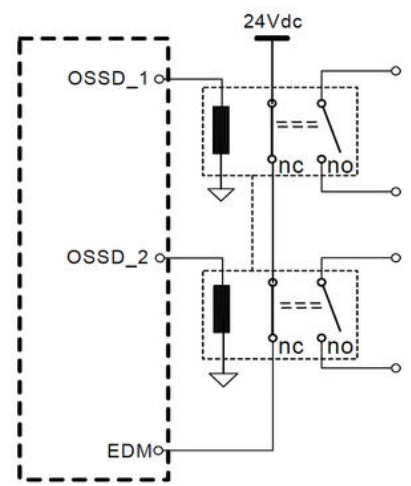
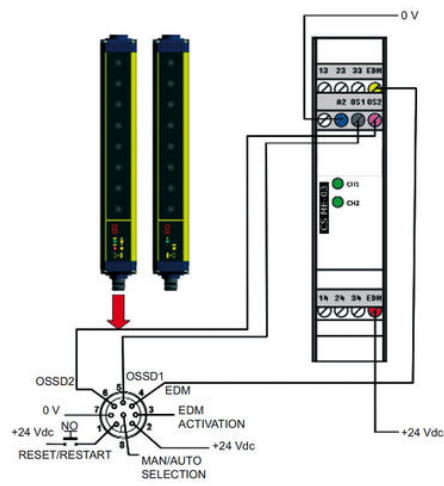
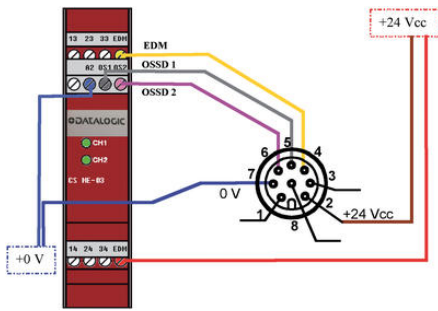

to ESPE forced guide relais

