

**POWER SUPPLY 3-PHASE, 24 V DC  
DIMENSION Q SERIES**

QT20.241  
POWER SUPPLY 24VDC 480W 20A

- Output current of 20 A
- 95% efficiency
- 65 mm wide
- 50% bonus power
- Maximum performance



**PRODUCT DESCRIPTION**

Puls Dimension Q is a new generation of power supply unit with very small construction dimensions and many technical benefits. The unit has low inrush current (even with warm starts), active PFC, which provides a power factor close to one, expanded temperature range and active protection against line transients. Furthermore, there is a relay output (DC OK) that is deactivated when the output voltage deviates more than 10% from the set value. The bonus power provides an extra 50% boost with retained 24 V, which is an advantage when connected loads have high starting currents. The unit also has a high short-circuit current that simplifies tripping of secondary fuses. Both the bonus power and short-circuit current are time-limited to 4 seconds to avoid constant overloading of the unit and wiring. High efficiency provides long lifetime and low temperatures. The power supply unit can be connected for 2-phase operation with  $I_{nom}$  up to 40°C. For higher temperatures, the load current must be reduced.

We recommend free space of 60 mm above/under the unit and 15 mm at the sides.

**Bonus power**

The power supply unit has bonus power that enables high power extraction with retained 24 V dc for 4 seconds, which is a major advantage when connected loads have high starting currents, such as the case with motors. How often bonus power can be utilised depends on the application. With the following diagram and formula, the repeat time can be calculated for each application. The bonus power is available as soon as the power supply unit is started and directly after a short circuit.

Bonus power

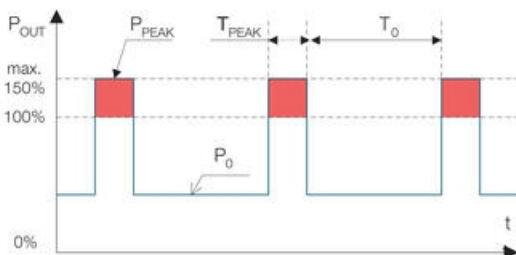

Operating characteristics

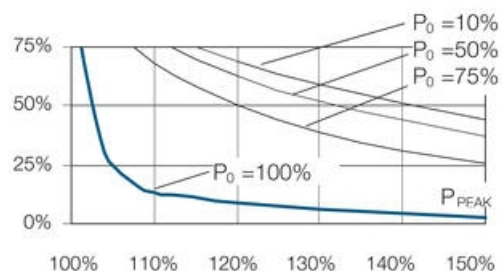

P<sub>0</sub>

Nominal load current

Ppeak	Peak current
To	Time between bonus power
Tpeak	Peak current I time
Operating cycle	$T_{peak} / (T_{peak} + T_o)$
To	$T_{peak} - (\text{operating cycle} * T_{peak}) / \text{operating cycle}$

Example: Nominal load current (Po) is 15 A. Peak current (Ppeak) is 24 A = 120%. The peak time is 3 seconds. 15 A = 75% of  $I_{nom}$ . According to the diagram, the operating cycle is 50%.  $T_o = 3 - (0.5 * 3) / 0.5 = 3$  Maximum repeat time of bonus power is 3 seconds.

## SPECIFICATIONS

Type Power Supply	AC-DC
Input voltage range	Wide-range
Power consumption at 400 V ac	0,79 A
Input voltage AC	380-480 V
Input voltage ac min	323 V AC
Input voltage ac max	552 V AC
Inrush current at 400 V ac typical	3 A
Number of phases	3
Power Factor at 400 V AC, full load. Typical	0,94
Supply Frequency	50-60 ±6 %
Ripple. max	100 mV pp
Output voltage min	24 V DC
Power Reduction Of 60 To 70 ° C	12 W/°C
Temperature Range Without Derating From	-25 °C
Output voltage	24 V DC
Output voltage max	28 V DC
Effect	480 W
Output Current	20 A
Temperature Range Without Derating To	60 °C
MTBF (IEC 61709) 400 V ac, max loan, +40 °C	690000 h
Lifetime at 400 V ac, full load and +40 ° C	105000 h
Efficiency At 400 V AC, full load. Typical	95 %
Efficiency At 400 V AC. Typical	94,2 %

<b>Weight</b>	0,87 kg
<b>Depth</b>	127 mm
<b>Width</b>	65 mm
<b>Height</b>	124 mm
<b>Clamp type</b>	Spring-clamp
<b>IP Class</b>	IP20
<b>Hold-up time at 400 V AC, full load. Typical.</b>	22 ms
<b>DC relay output</b>	Yes
<b>Series</b>	Dimension Q
<b>Approvals</b>	CB, CE, CSA, CSA US, cRUus, cULus, GL
<b>Material Protection</b>	Aluminium
<b>Active Transient</b>	Yes

Fig. 6-1 Output voltage vs. output current, typ.

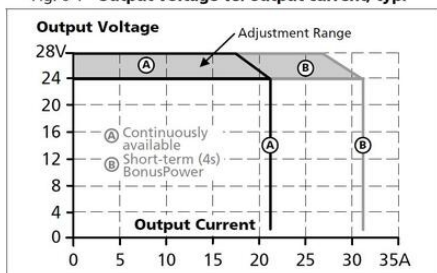

Fig. 15-1 Output current vs. ambient temp.

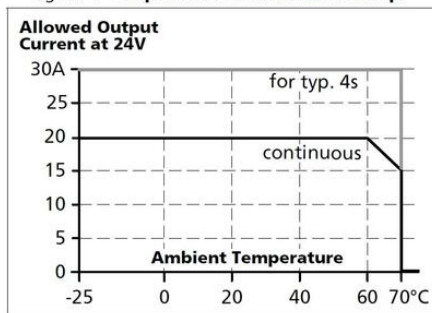

Fig. 6-2 Bonus time vs. output power

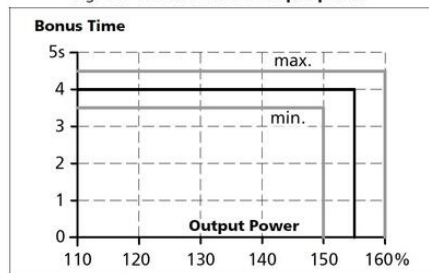

Fig. 9-1 Efficiency vs. output current at 24V, typ.

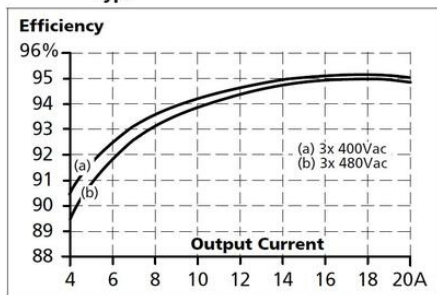
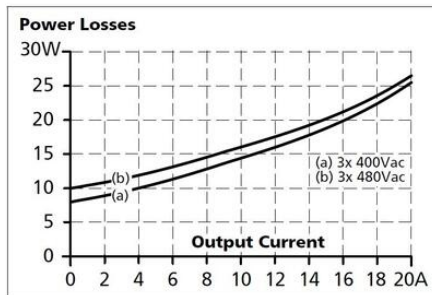

Fig. 9-2 Losses vs. output current at 24V, typ.



Maximal wire length<sup>1)</sup> for a fast (magnetic) tripping:

	0.75mm <sup>2</sup>	1.0mm <sup>2</sup>	1.5mm <sup>2</sup>	2.5mm <sup>2</sup>
<b>C-2A</b>	29m	39m	56m	86m
<b>C-3A</b>	26m	34m	49m	76m
<b>C-4A</b>	16m	21m	29m	46m
<b>C-6A</b>	3m	5m	7m	8m
<b>C-8A</b>	1m	2m	2m	3m
<b>C-10A</b>	1m	1m	1m	1m
<b>B-6A</b>	18m	23m	31m	54m
<b>B-10A</b>	4m	6m	7m	13m
<b>B-13A</b>	3m	5m	6m	11m
<b>B-16A</b>	1m	1m	1m	2m

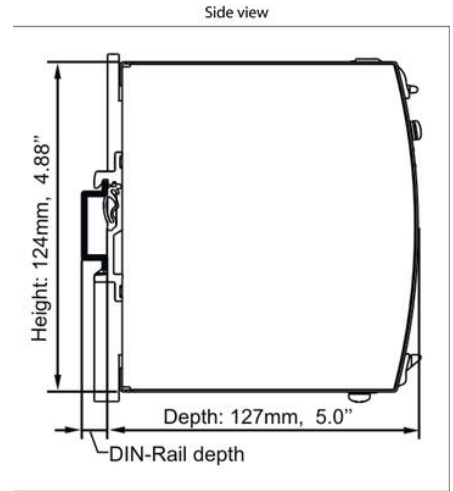
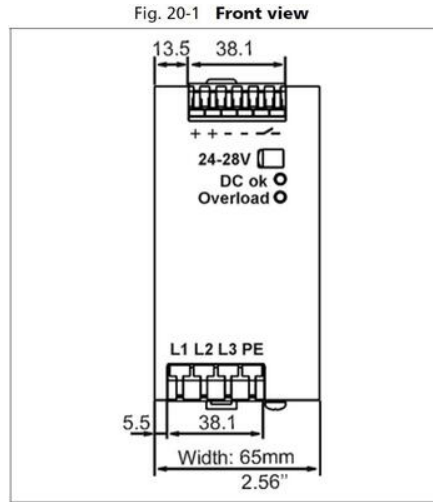
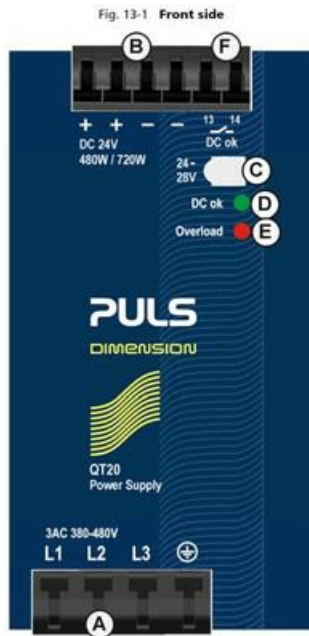

Fig. 6-1 Output voltage vs. output current, typ.

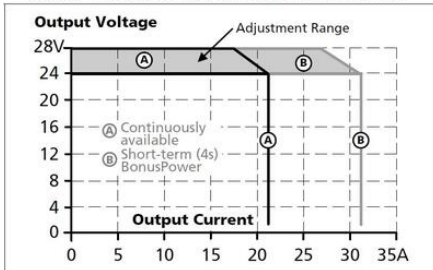

Fig. 15-1 Output current vs. ambient temp.

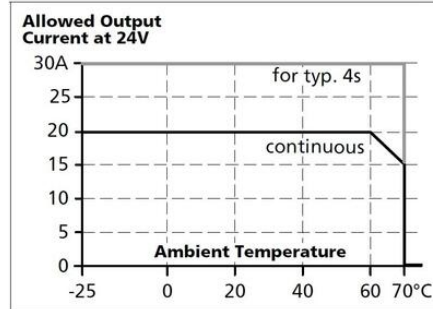

Fig. 6-2 Bonus time vs. output power

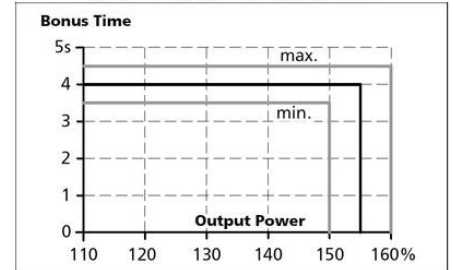

Fig. 9-1 Efficiency vs. output current at 24V, typ.

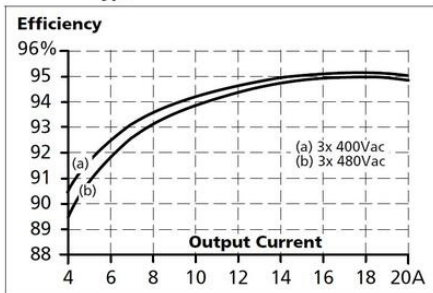
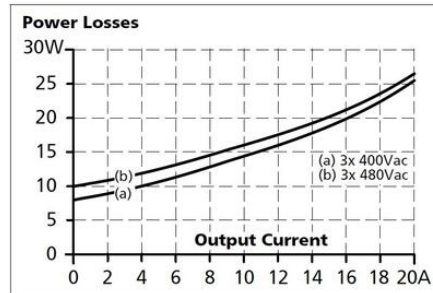

Fig. 9-2 Losses vs. output current at 24V, typ.



Maximal wire length<sup>1)</sup> for a fast (magnetic) tripping:

	0.75mm <sup>2</sup>	1.0mm <sup>2</sup>	1.5mm <sup>2</sup>	2.5mm <sup>2</sup>
C-2A	29m	39m	56m	86m
C-3A	26m	34m	49m	76m
C-4A	16m	21m	29m	46m
C-6A	3m	5m	7m	8m
C-8A	1m	2m	2m	3m
C-10A	1m	1m	1m	1m
B-6A	18m	23m	31m	54m
B-10A	4m	6m	7m	13m
B-13A	3m	5m	6m	11m
B-16A	1m	1m	1m	2m

Fig. 13-1 Front side

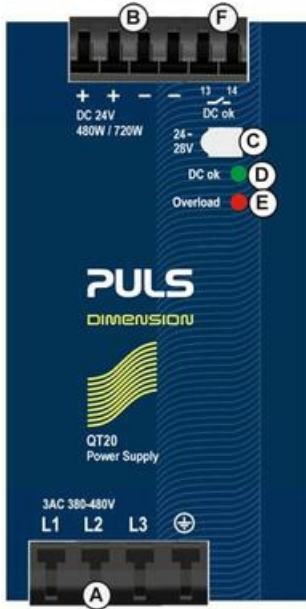
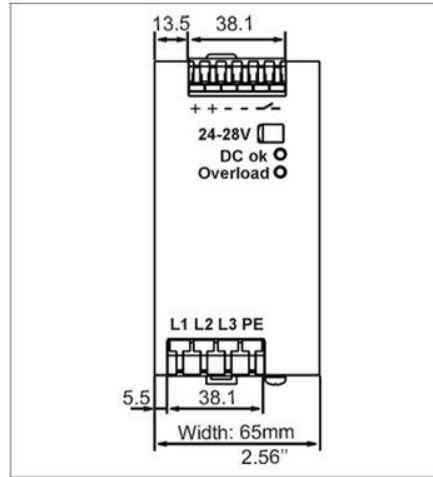

Fig. 20-1 Front view



Side view

