

ORLACO - FAMOS

ORL0171070
CAMERA FAMOS 170 PAL

- Robust construction for extreme environments
- 12 or 24 V DC
- operating temperature -40 to +85 °C
- Epoxy-filled, better protection against moisture



PRODUCT DESCRIPTION

These cameras are available in several different viewing angles to suit the various applications they can be used in. For example, if you want to see details in a long way, choose a narrower opening angle and instead you want a cross-section view, choose a further opening angle. Orlaco cameras are suitable for all types of vehicles, regardless of whether you need a power camera, back camera or side camera.

Orlaco's new FAMOS camera is not gas-filled as the traditional clover camera has been before, but it's epoxy-filled instead. This has provided better protection against moisture.

SPECIFICATIONS

Camera Angle	170
Image Format	PAL
IP Class	IP68, IP69K
Supply Voltage DC Max	24 V DC
Supply Voltage DC Min	12 V DC

Temperature range from -40 °C

Temperature range to 85 °C

Vibration Resistance 50G

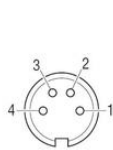

Electrical connections
Front side of molded 4p male connector
1 = Coax core = Video signal
2 = Coax screen = Video GND
3 = Red = 12...24V/DC
4 = Black/orange = 0V
Shielding To connector housing

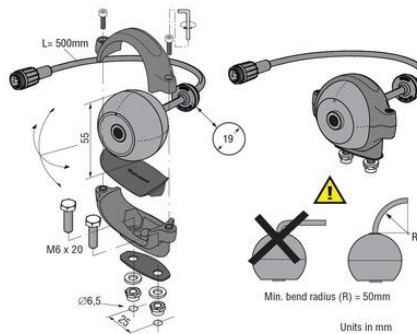

Electrical connections
Front side of molded 4p male connector
1 = Coax core = Video signal
2 = Coax screen = Video GND
3 = Red = 12...24V/DC
4 = Black/orange = 0V
Shielding To connector housing

